



Pressure Pipe Fittings and Valves
Made of Ductile Cast Iron

Drainage Pipe Systems
Made of Grey Cast Iron



Düker GmbH

The Company Düker

The company's first mention in records dates back to the year 1469. The village of Laufach holds the origins of a medium-sized company, which is today among the leading manufacturers of valves and pressure pipe fittings for water and gas supply as well as pipes and fittings for drainage of waste water.

Furthermore, Düker manufactures custom-made castings for the printing, automotive and mechanical engineering sectors.

At the two sites of Karlstadt and Laufach in Lower Franconia (Bavaria), there are today approximately 500 employees, among them up to 10% of apprentices. Düker is therefore among the largest German iron foundries.





Find Düker
at YouTube!

Production and Sales Programme at a Glance

Site	Product Sector	Products
Karlstadt	Drainage Technology	<ul style="list-style-type: none"> • drainage pipe systems for drainage of buildings and sites
Laufach	Fittings and Valves	<ul style="list-style-type: none"> • for water supply systems (underground construction): • pressure pipe fittings and flanged pipes • valves for water and gas supply • thrust-resisting joint systems for the connection of cast iron and PE-HD pipelines
Karlstadt / Laufach	Jobbing Foundry	<ul style="list-style-type: none"> • small, medium and large production series in various cast iron qualities

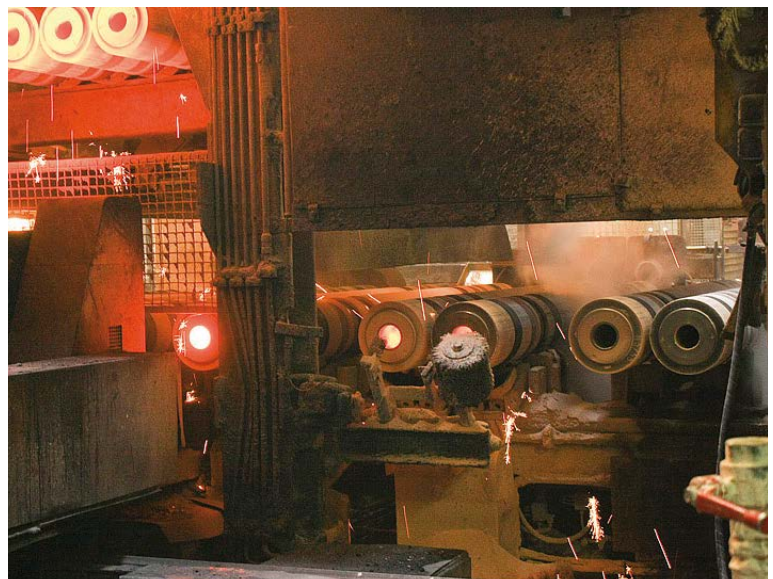

Certified Quality





Regular tests, such as pressure tests, guarantee a permanently high product quality.

Düker makes high demands on product quality and therefore introduced a modern certified quality management system as per EN ISO 9001, as early as in 1993.

Furthermore, Düker and the Düker products have been tested and approved against many other rules and standards, part of which are specific to certain products or markets.

In the framework of certain quality assurance associations, Düker observes voluntarily criteria which surpass the standard requirements by far.

DVGW type examination certificate
DVGW-Baumusterprüfzertifikat

DW-7705BM0297
Registration Number
Registrierungsnummer

Field of Application Anwendungsbereich	products of water supply Produkte der Wasserversorgung
Owner of Certificate Zertifikatsinhaber	Düker GmbH Hauptstraße 39-41, D-63846 Laufach
Distributor Vertrieber	Düker GmbH Hauptstraße 39-41, D-63846 Laufach
Product Category Produktart	ductile iron pipe fittings: Ductile iron fittings (7705)
Product Description Produktbezeichnung	Ductile iron fittings for the drinking water supply
Model Modell	Gusseisenformstücke W "Düker"
Test Reports Prüfberichte	laboratory control test: 11 7404-17-01 from 28.04.2017 (MPG) laboratory control test: 11 7404-17-02 from 28.04.2017 (MPG) type testing: 11 740412 from 27.02.2013 (MPG) KTW testing: KA 0213/13 from 30.05.2016 (TZW) hygienic testing: MO 192/17 from 18.10.2017 (TZW)
Test Basis Prüfgrundlagen	DVGW GW 337-P (01.09.2010) DIN EN 845 (01.09.2011) UBA KTW (07.03.2016) DVGW W 270 (01.11.2007) DVGW W 347 (01.04.2006) DVGW W 348 (01.09.2004)
Date of Expiry / File No. Ablaufdatum / Aktenzeichen	18.06.2023 / 18-0168-WNV

06.06.2018 GI A-1/2
Date, issued by: Stefan Heise of Certification Body
Datum, erteilt durch: Stefan Heise der Zertifizierungsstelle

DVGW CERT GmbH is an accredited body by DAKKS according to DIN EN ISO/IEC 17065:2013 for certification of products for energy and water supply industry

DVGW CERT GmbH ist von der DAKKS nach DIN EN ISO/IEC 17065:2013 akkreditierte Stelle für die Zertifizierung von Produkten der Energie- und Wasserversorgung



DVGW CERT GmbH
Zertifizierungsstelle
Josef Wimmer Str. 1-3
53123 Bonn
Tel. +49 228 91 88 - 888
Fax +49 228 91 88 - 993
www.dvge-cert.com
info@dvge-cert.com



CERTIFICATE



Düker GmbH
Würzburger Straße 10-16
97753 Karlstadt
Germany

with the organizational units/sites as listed in the annex

has implemented and maintains a **Quality Management System**.

Scope:
Development, manufacture, supply and service of cast iron drainage pipe systems, castings made to specification, ductile iron shut-off valves and pressure pipe fittings, highly acid-resistant glass-lined components.

Through an audit, documented in a report, it was verified that the management system fulfills the requirements of the following standard:

ISO 9001 : 2015

Certificate registration no. 511876 QM15
Valid from 2018-04-11
Valid until 2021-04-10
Date of certification 2018-04-11

DQS GmbH
Stefan Heise
Managing Director

Accredited Body: DQS GmbH, August-Schanz-Straße 21, 60433 Frankfurt am Main, Germany







1 / 2

Düker feels obliged to the environment as well as to the economic and social needs of their staff and of society.

Sustainability is an integral part both of the business culture and of everyday activities, and is based on the three pillars economy, social responsibility and environmental responsibility.

This goes hand in hand with a continuous examination of the matter of energy efficiency, which is crucial in a company with elevated use of material and energy. Therefore, Düker took part in the project "ÖKOPROFIT" and received the corresponding award in 2010.

In 2011, Düker introduced an environmental management system as per EN ISO 14001 and an energy management system as per EN 50001.



Fittings

Pressure Pipe Fittings

Düker pressure pipe fittings and flanged pipes are manufactured exclusively from ductile cast iron. Due to the positive material features, the products withstand temperature changes, elevated inside and outside pressures and other external influences. All fittings for water supply systems are in accordance with EN 545 and ISO 2531. In addition, the Düker fittings for sewage systems observe the requirements of EN 598.

Surface Protection

Corrosion resistance can only be obtained through an effective and durable surface protection. The requirements vary strongly according to the application. Therefore Düker offers surface protection systems suitable for their application.

Range of Coatings:

1. inside: cement-mortar lining as per EN 545
outside: Fria-zink "R" and bituminous coating
2. inside and outside: epoxy powder coating, heavy-duty corrosion protection as per the directives of GSK; blue for potable water or red for sewage
3. inside: enamel, the best protection against corrosion, abrasion and incrustation
4. inside and outside: etec enamel, the best protection against corrosion, abrasion and incrustation
5. special coatings on request



Düker fittings correspond to the DVGW directives, the largest European certifying institute of the gas and water sector, which covers all certifying processes required in the sector.

Furthermore, Düker is a member of FGR /EADIPS, a technical and scientific association whose membership comprises European companies producing ductile cast iron pipes, fittings and valves.













Socket and Flange Fittings





With our wide and varied range of fittings in accordance with **DIN EN 545**, completed with our special fittings, we offer the most suitable solution for almost every application.

With the addition of the thrust-resisting joint systems, developed in part by Düker, Düker **SMU**, Düker **SPEZIAL**, **TYTON® SIT®**, **TYTON SIT PLUS®**, **NOVO-SIT®** and **NOVO-Grip®** you can be sure to have safe and reliable connections.

Socket Fittings





DN		40	50	65	80	100	125	150	200	250	300	350	400	500	600	700	800	900	1000	1200	1400	1600	
E		•		•	•	•	•	•	•	•	•	•	•	•	•	•	•	•	•	•	•	•	•
EN					•	•		•	•														
EQ		•			•	•																	
EU		•	•	•	•	•	•	•	•	•	•	•	•	•	•	•	•	•	•	•	•	•	•
MK 11°- 45°		•	•	•	•	•	•	•	•	•	•	•	•	•	•	•	•	•	•	•	•	•	•
MMK 11°- 45°		•	•	•	•	•	•	•	•	•	•	•	•	•	•	•	•	•	•	•	•	•	•
MMQ		•	•	•	•	•	•	•	•	•	•	•	•	•	•	•	•	•	•	•	•	•	•
MQ		•	•	•	•	•	•	•	•	•	•	•	•	•	•	•	•	•	•	•	•	•	•
P		•	•		•	•	•	•	•	•	•	•	•	•	•	•	•	•	•	•	•	•	•
U		•	•	•	•	•	•	•	•	•	•	•	•	•	•	•	•	•	•	•	•	•	•





Flanged Fittings

DN		40	50	65	80	100	125	150	200	250	300	350	400	500	600	700	800	900	1000	1200	1400	1600	
F		•	•	•	•	•	•	•	•	•	•	•	•	•	•	•	•	•	•	•	•	•	•
FF		•	•	•	•	•	•	•	•	•	•	•	•	•	•	•	•	•	•	•	•	•	•
FFK 11°- 45°		•	•	•	•	•	•	•	•	•	•	•	•	•	•	•	•	•	•	•	•	•	•
N		•	•	•	•	•	•	•	•	•	•	•	•	•	•	•	•	•	•	•	•	•	•
Q		•	•	•	•	•	•	•	•	•	•	•	•	•	•	•	•	•	•	•	•	•	•
X	—	•	•	•	•	•	•	•	•	•	•	•	•	•	•	•	•	•	•	•	•	•	•
conversion flange					•																		
single flange bell		•	•	•	•	•	•	•	•	•	•	•	•	•	•	•	•	•	•	•	•	•	•





Socket and Flange Fittings with Reduction





Socket Fittings with Reduction

DN ₁ DN ₂	40 40	50 40 50	65 40 50 65	80 40 50 65 80	100 40 50 65 80 100	125 40 50 65 80 100 125	150 40 50 65 80 100 125 150	40 50
A 	•	• •		• • •	• • • • •	• • • • •	• • • • • •	•
B 	•			•	• •	• • •	• • • •	
MMA 	•	• • •	• • •	• • • •	• • • • •	• • • • • •	• • • • • • •	• •
MMB 	•	• • •	• • •	• • • •	• • • • •	• • • • • •	• • • • • • •	• •
MMR 		•	• •	• • •	• • • •	• • •	• • • •	

DN ₁ DN ₂	500										600										700									
	80	100	150	200	250	300	350	400	500	80	100	150	200	250	300	350	400	500	600	100	150	200	250	300	400	500	600	700		
A 																														
B 																														
MMA 	•	•	•	•	•	•	•	•	•	•	•	•	•	•	•	•	•	•	•	•	•	•	•	•	•	•	•	•		
MMB 	•	•	•	•	•	•	•	•	•	•	•	•	•	•	•	•	•	•	•	•	•	•	•	•	•	•	•	•		
MMR 					•	•	•	•							•	•	•	•							•	•	•			

Flanged Fittings with Reduction

DN ₁ DN ₂	40 40	50 40 50	65 40 50 65	80 40 50 65 80	100 40 50 65 80 100	125 40 50 65 80 100 125	150 40 50 65 80 100 125 150	40 50
FFR 		•	• •	• • •	• • • •	• • • • •	• • • • • •	•
FFRe 				• • •	• • •	• • •	• • • •	
T 		• •	• • •	• • • •	• • • • •	• • • • • •	• • • • • • •	• •
TT 	•	• • •	• • •	• • • •	• • • • •	• • • • • •	• • • • • • •	• •

DN ₁ DN ₂	500										600										700									
	80	100	150	200	250	300	350	400	500	80	100	150	200	250	300	350	400	500	600	100	150	200	250	300	400	500	600			
FFR 					•	•	•	•							•	•	•	•							•	•	•			
FFRe 					•	•	•	•							•	•	•	•							•	•	•			
T 	•	•	•	•	•	•	•	•	•	•	•	•	•	•	•	•	•	•	•	•	•	•	•	•	•	•	•			
TT 	•	•	•	•	•	•	•	•	•	•	•	•	•	•	•	•	•	•	•	•	•	•	•	•	•	•	•			







200					250					300					350					400												
80	100	125	150	200	40	80	100	125	150	200	250	80	100	150	200	250	300	80	100	150	200	250	300	350	80	100	150	200	250	300	350	400
•	•		•	•								•	•	•																		•
•	•		•	•		•				•			•	•	•		•															
•	•	•	•	•	•	•	•	•	•	•	•	•	•	•	•	•	•	•	•	•	•	•	•	•	•	•	•	•	•	•	•	•
•	•	•	•	•	•	•	•	•	•	•	•	•	•	•	•	•	•	•	•	•	•	•	•	•	•	•	•	•	•	•	•	•
•	•	•	•		•	•	•	•	•	•		•	•	•	•	•				•	•	•	•				•	•	•	•		







800								900				1000					1200				1400				1600							
100	200	300	400	500	600	700	800	250	400	600	700	800	900	600	700	800	900	1000	600-900	1000	1200	600-1000	1200	1400	600-1000	1200	1400	1600				
														•																		
•	•	•	•	•	•	•	•	•	•	•	•	•	•	•	•	•	•	•	•	•	•				•				•	•		
•	•	•	•	•	•	•	•	•	•	•	•	•	•	•	•	•	•	•	•	•	•				•	•	•		•	•	•	•
				•	•	•				•	•	•				•					•						•		•	•		







200					250					300					350					400												
80	100	125	150	200	40	80	100	125	150	200	250	80	100	150	200	250	300	80	100	150	200	250	300	350	80	100	150	200	250	300	350	400
•	•	•	•		•	•	•	•	•	•		•	•	•	•	•				•	•	•	•			•	•	•	•		•	
•	•	•	•				•	•	•	•			•	•	•	•					•	•	•			•	•	•	•		•	
•	•	•	•	•	•	•	•	•	•	•	•	•	•	•	•	•	•	•	•	•	•	•	•	•	•	•	•	•	•	•	•	•
•	•	•	•	•	•	•	•	•	•	•	•	•	•	•	•	•	•	•	•	•	•	•	•	•	•	•	•	•	•	•	•	•

700	800								900				1000					1200				1400				1600			
	100	200	300	400	500	600	700	800	600	700	800	900	600	700	800	900	1000	600	700	800	900	1000	1200	600-1200	1400	600-1200	1400	1600	
				•	•	•	•		•	•	•		•	•	•	•						•	•						
				•	•	•									•														
•	•	•	•	•	•	•	•	•	•	•	•	•	•	•	•	•	•	•	•	•	•	•	•	•	•	•	•	•	•
•																													

KS Fittings

DN ₁ DN ₂		50		65			80				100					125					
		40	50	40	50	65	40	50	65	80	40	50	65	80	100	40	50	65	80	100	125
E-KS			•			•				•					•						•
EN-KS										•					•						
F-KS			•			•				•					•						•
MMA-KS		•	•		•	•	•	•	•	•	•	•	•	•	•	•	•	•	•	•	•
MMB-KS			•		•	•		•	•	•		•	•	•	•		•	•	•	•	•
MMI-KS			•			•				•					•						•
MMR-KS					•			•	•			•	•	•					•	•	

DN ₁ DN ₂		40		150						200						250					
		50	65	80	100	125	150	40	50	80	100	125	150	200	40	80	100	125	150	200	250
E-KS													•								•
EN-KS													•								
F-KS													•								•
MMA-KS		•	•	•	•	•	•			•	•	•	•	•	•	•	•	•	•	•	•
MMB-KS			•	•	•	•	•			•	•	•	•	•		•	•	•	•	•	•
MMI-KS													•								•
MMR-KS					•	•	•				•	•				•	•		•	•	

DN ₁ DN ₂		300						400							
		80	100	150	200	250	300	80	100	150	200	250	300	350	400
E-KS							•								•
EN-KS															
F-KS							•								•
MMA-KS		•	•	•	•	•	•	•	•	•	•	•	•	•	•
MMB-KS															
MMI-KS							•								
MMR-KS															





E-KS

For technical details, please ask for our detailed fittings catalogue online or printed.

Special Fittings

Special Fittings

DN ₁ DN ₂	80				100					125					
	40	50	65	80	40	50	65	80	100	40	50	65	80	100	125
MMC 	•	•	•	•	•	•	•	•	•	•	•	•	•	•	•
hatchbox				•					•						•

DN ₁ DN ₂	150							200						250							
	40	50	65	80	100	125	150	40	50	80	100	125	150	200	40	80	100	125	150	200	250
MMC 	•	•	•	•	•	•	•	•	•	•	•	•	•	•	•	•	•	•	•	•	•
hatchbox							•							•							•

DN ₁ DN ₂	300						350						400								
	80	100	150	200	250	300	80	100	150	200	250	300	350	80	100	150	200	250	300	350	400
MMC 	•	•	•	•	•	•	•	•	•	•	•	•	•	•	•	•	•	•	•	•	•
hatchbox						•							•								•

DN ₁ DN ₂	500								600										
	80	100	150	200	250	300	350	400	500	80	100	150	200	250	300	350	400	500	600
MMC 	•	•	•	•	•	•	•	•	•	•	•	•	•	•	•	•	•	•	•
hatchbox									•										

DN ₁ DN ₂	700								800								
	100	150	200	250	300	400	500	600	700	100	200	300	400	500	600	700	800
MMC 	•	•	•	•	•	•	•	•	•	•	•	•	•	•	•	•	•
hatchbox																	

Every socket fitting is available with the following socket types:

- TYTON® socket
- bolted-gland socket
- Novo socket
- KS socket
- screw-gland socket
- partly STANDARD socket

Valves

Valves

Just like all pressure pipe fittings and flanged pipes, Düker valves are also manufactured from ductile cast iron. Modern production processes and numerous controls assure the approved quality.

Range of Products

The Düker range of valves includes among other things gate valves, butterfly valves, hydrants as well as house connection and tapping valves.

Surface Protection

In order to ensure the corrosion resistance, Düker offers a durable surface protection for the valves. You can choose between an all around epoxy coating or a complete enamelling with etec® enamel.

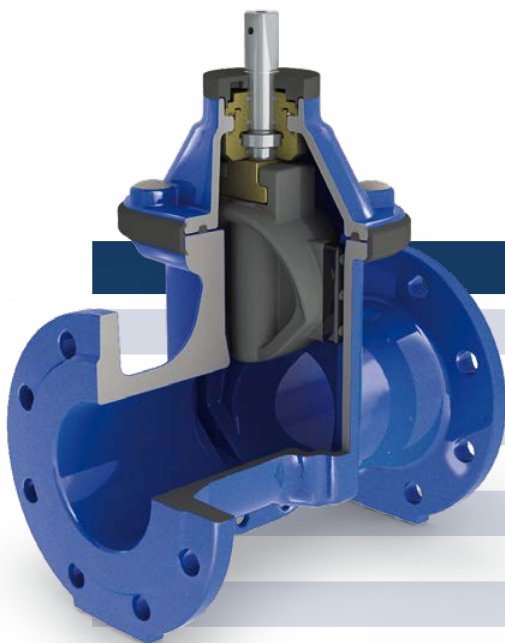

Gate valve type 4004 with flanges (DN 40 - 300)

Gate Valves	Design		PN	
Type 4004	with flanges	DN 40 - 300	16 (water)	16 (gas)
Type 4004	with socket connections	DN 80 - 300	16 (water)	
Type 4004	with PE-HD connections	Ø 80 - 225	16 (water)	10 (gas)
Type 4004	with flanges (replacement gate valve)	DN 80 - 200	16 (water)	
Type 2004	with flanges	DN 40 - 300	16 (water)	16 (gas)
Type 2004	with flanges (replacement gate valve)	DN 80 - 200	16 (water)	
Type 3004	with welding ends	DN 50 - 300	16 (gas)	



Gate valve type 3004 with welding ends (also as blow-out gate valve)



Replacement gate valve type 4004 with flanges (DN 80 - 200)



Gate valve type 4004 with PE-HD connections (also as blow-out gate valve)



Gate valve type 4004 with Novo sockets

Butterfly Valves	Design	DN	PN
Type 4510	with handwheel	100 - 600	10/16 (water)
Type 451	with handwheel	700 - 1200	10/16 (water)
Type 4510	for underground installation	100 - 600	10/16 (water)
Type 451	for underground installation	700 - 1200	10/16 (water)
Type 4510	with electric actuator	100 - 600	10/16 (water)
Type 451	with electric actuator	700 - 1200	10/16 (water)
Type 4510	with Novo socket connections	150 - 500	10/16 (water)
Type 4510	with bypass	300 - 600	10/16 (water)
Type 451	with bypass	700 - 1000	10/16 (water)

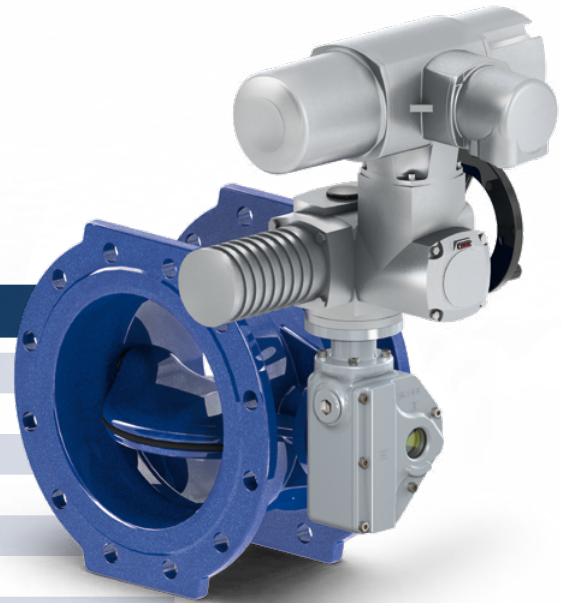

Butterfly valve type 4510 with electric actuator

PN 25 on request
Gas on request



Butterfly valve type 4510 with handwheel



Butterfly valve type 451 for underground installation



Butterfly valve type 4510 with Novo sockets connections

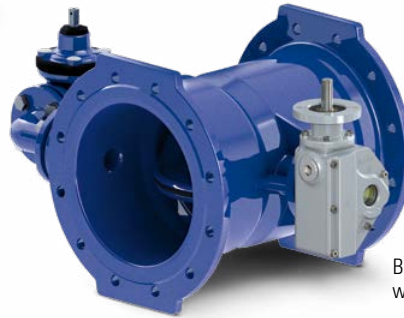

Butterfly valve type 451 with bypass



Pillar fire hydrant type 494



Underground fire hydrant type 305

Pillar fire hydrants

Design	PN	
Type 494	Design AUD	16 (water)
Type 495	Design AFUD	16 (water)

Underground fire hydrants

Design	PN	
Type 304	with flange	16 (water)
Type 305 (with double obturator)	with flange	16 (water)
Type 304 S	with spigot	16 (water)

Valves

House connection valves	Design	PN
Type 1014	with internal pipe thread	16 (water)
Type 1014	with PE-HD connection	16 (water)
Type 1004	TOP / vertical drilling	16 (water)
Type 1004	TOPsi / horizontal drilling	16 (water)
Type 1004	with internal pipe thread	16 (water/gas)
Type 1004	with PE-HD connections	16/10 (water/gas)
tapping clamp	with internal pipe thread	



Tapping valve TOP 1014



Tapping clamp with internal pipe thread



Tapping valve type 1004 / TOP for vertical drilling

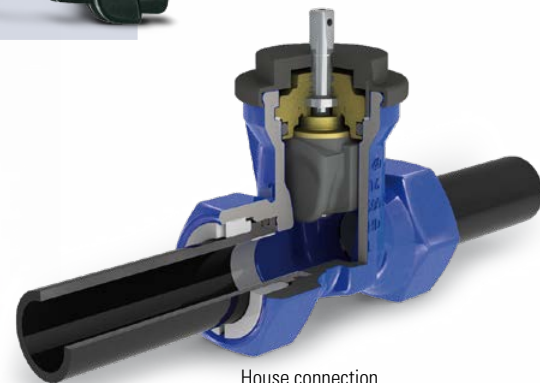

House connection valve type 1004 with PE-HD connections

Non-slam check valve	Design	DN	PN
Type 8015	H+V = horizontal and vertical upwards V = vertical downwards	150-300	10-40 (water)
required back pressure for tightness: 0.5 bar			

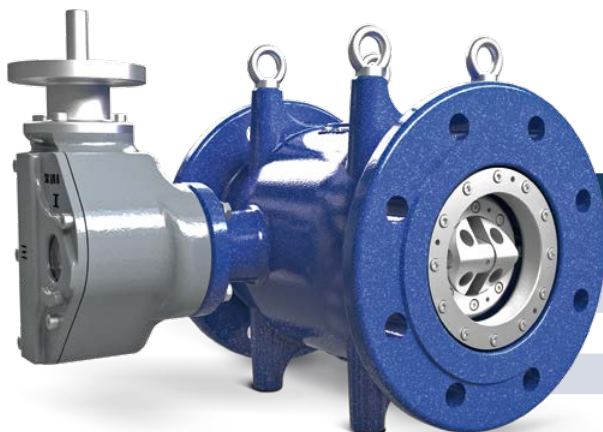

Plunger Valve	DN	PN
Type RKV 7015	150-300	10-40 (water)

Thrust-Resisting Joints

For all fittings and valves with screw-gland, TYTON® or Novo socket, Düker offers the appropriate joint system for a thrust-resisting and safe connection. The structured thrust-resisting joint systems, targeted on the individual field of application, are suitable for any range of application.

Due to faster installation, the saving of efforts and material and the reduction of stockholding, the Düker plug-in connections save time, cost and material in comparison to flanged systems. Appropriate thrust-resisting joint systems secure the connections optimally and keep them movable.



Thrust-Resisting Joint Systems at a Glance

thrust-resisting joint	nominal width	operating pressure PN	deflection angle
TYTON SIT PLUS®	80 - 600	10 - 32	2° - 3°
NOVO-SIT®	80 - 800	10 - 25*	1° - 3°
NOVO-Grip® III	90 - 225	16	

* up to 40 bar on request



Cast Iron Drainage Pipe Systems

Drainage pipe systems as per EN 877 and DIN 19522 for the evacuation of water from buildings and sites, made of grey cast iron with flake graphite, type at least EN-GJL-150.

Cast iron drainage pipe systems contribute to the preventive fire protection and to the noise protection in buildings. They are used primarily in public buildings such as hotels, hospitals, stadiums etc.

The conformity with EN 877 is demonstrated through the CE marking and the Declaration of Performance (DOP) as per the European Construction Products Regulation (CPR). The superior quality of Düker drainage pipe systems, above the requirements of the standard, is proven by various international test symbols and certificates, some of which are shown here.



Pipe system	Colour	Nominal width	Pipe inside coating	Pipe outside coating
SML	brown-red	DN 50 up to 300 or 400	ocre-coloured completely cross-linked epoxy	anti-corrosive primer
MLK-protec	dark grey	DN 50 up to 400	ocre-coloured completely cross-linked epoxy in double layer thickness	spray zinc coating, min. 130 g/m ² , 2-components cover coat
MLK-indoor	dark grey	DN 50 up to 400	ocre-coloured completely cross-linked epoxy in double layer thickness	anti-corrosive primer
TML	brown	DN 100 up to 200	see SML	spray zinc coating, min. 130 g/m ² , 2-components cover coat
MLB	silvery grey	DN 100 up to 500 or 600	see SML	two-layered spray zinc coating (min. 40 µm), 2-components epoxy coating (80 µm)

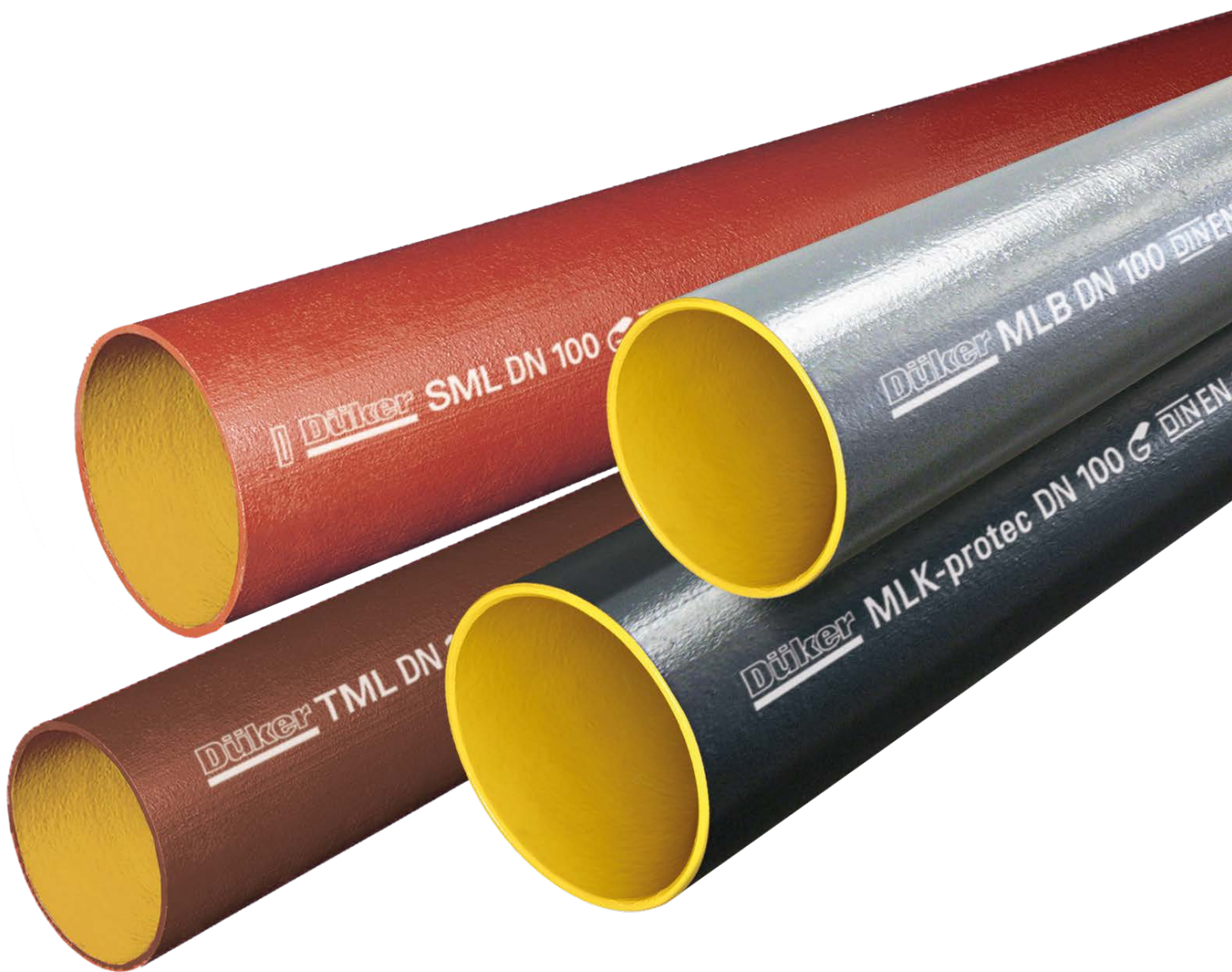

Coating of fittings	Typical application
wet epoxy dip coating brown-red inside and outside	domestic waste water and rain water installed inside buildings and on the outside of buildings
epoxy powder coating dark grey inside and outside	aggressive waste waters such as grease- containing waste waters from professional kitchens, underground installation
epoxy powder coating dark grey inside and outside	aggressive waste waters such as grease- containing waste waters from professional kitchens, indoor installation
epoxy powder coating brown inside and outside	domestic waste water and rain water in underground installation
epoxy and zinc powder coating (70 µm), epoxy cover coat (80 µm)	bridge drainage



No. 04/1
SML DN 50 - 400
MLK-protec DN 50 - 400



No. 04/4189
SML/TML



No. KM 613802
SML/TML



Couplings

Model	Nominal width	Material metal collar	Locking parts	Rubber sealing	
				EPDM	NBR*
Dükorapid®	DN 50 - 200	stainless steel	galvanised	•	-
Dükorapid® Inox	DN 50 - 200	inox/austenitic stainless steel	stainless steel	•	-
Rapid Inox	DN 50 - 300	inox/austenitic stainless steel	stainless steel	•	•
CV	DN 50 - 300	stainless steel	galvanised	•	-
CE	DN 50 - 300	austenitic stainless steel	stainless steel	•	-
CE dual ring coupling	DN 400	austenitic stainl. steel	stainless steel	•	-
Connect-G Inox	DN 50 - 600	inox/austenitic stainless steel	stainless steel	•	-
Connect-F Inox	DN 100 - 600	inox/austenitic stainless steel	stainless steel	•	-
SVE	DN 70 - 200	polypropylene-Co	-	-	-
Düker EK Fix	DN 50 - 125	EPDM	stainless steel	-	-
Konfix Multi	DN 100	EPDM	stainless steel	-	-
Multiquick	DN 100	EPDM	stainless steel	-	-
BSV 90	DN 80 - 150	stainless steel	galvanised	•	-

* NBR as an option for waste waters containing oil, grease, solvents, petrol and fuel
 ** pressure tightness of all metallic couplings, measured without axial forces: 5 bar up to DN 200, 3 bar above DN 200.
 The axial restraint mentioned in the table can vary according to the nominal diameter.

Grip collars with axial restraint



Döker Kombi grip collar

Model	Nominal width	To be installed with	Material	Axial restraint
Döker Kombi grip collar	DN 50 - 300	Dükorapid®, Rapid Inox, CV, CE	steel galvanised	up to 10 bar
Döker grip collar	DN 400	CE dual ring coupling	galvanised	up to 1 bar

Typical applications: in the back water area, in siphonic roof drainage, in pressure pipelines of waste water pumps

Axial restraint**	Typical application
up to 0.5 bar	inside buildings, in concrete
up to 0.5 bar	underground installation, outside installation
up to 0.5 bar	underground installation, outside installation
-	for repairs
-	inside buildings
-	inside buildings
up to 10 bar	bridge drainage
-	bridge drainage
-	underground installation
-	connection to plastic pipes
-	connection to plastic pipes
-	connection to plastic pipes
-	ceiling penetrations with fire rating



Düker EK Fix



Konfix Multi



Dükorapid®



Connect-G Inox



Connect-F Inox



FITTINGS AND VALVES

DRAINAGE TECHNOLOGY

JOBGING FOUNDRY

Düker GmbH

Würzburger Str. 10-16
97753 Karlstadt / Main
Germany

Phone +49 6093 87-570

Fax +49 6093 87-8570

E-Mail: sales.drainage-tech@dueker.de

Phone +49 6093 87-560

Fax +49 6093 87-246

E-Mail: sales.fittings-valves@dueker.de